

Article number: 20424410

Description: E+G Ball knob DIN 319-NI-20-M5-C
St. steel

Measures

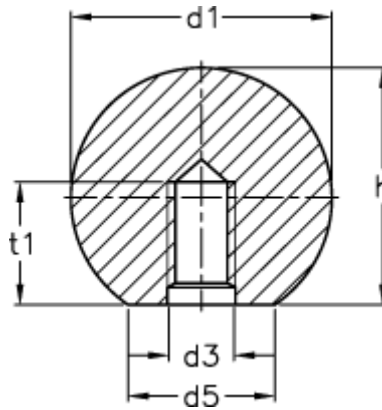

d1	= 20
d3	= M5
d5	= 12
h	= 18.0
t1 min.	= 9.0